



FOREST CORDED SERIES



EASY
INSTALL



CORDED
CONTROL

Heavy duty corded curtain track systems with separate internal cord channels; preventing cord sag and eliminating cord tangle.

FOREST CKS® CORDED
FOREST CCS® CORDED
FOREST CRS® CORDED
FOREST DS-XL® CORDED

THE WORLD
BEHIND
YOUR
CURTAINS



FOREST CKS® CORDED



PRODUCT INFORMATION

- Highly efficient cord traversing system with separate internal cord channels; preventing cord sag and eliminating cord tangle.
- Quick installation with “Smart Klick” brackets for wall and ceiling applications.
- Bendable; it can be bent and reverse bent by using a 10 cm (4”) radius or continuous curved.
- Heavy duty clickable carriers - UV protected - for smooth and easy traversing. Offset shape for straight hanging pleats.
- Can also be used for ripplefold or accordiafold drapery systems.
- Maximum fabric weight: ± 6 kg per metre (4,5 LBS per ft.). Overall max weight, 40 kg.
- Colours available: white, grey and black.
- Available lengths: 4 m (13'1”), 5 m (16'4”), 6 m (19'8”).
- Track finish: powder coated with a factory applied patented dry lubricant.
- Warranty: 10 years.

FEATURES

- Shown actual size 1:1
- Aluminium Extrusion
- Weight: 202 grams per metre (2.17 ounce per ft.)
- Dimensions: 14 mm x 20 mm (0,6” x 0,8”)

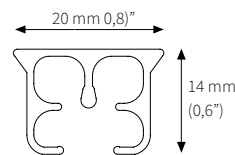

25 mm
(1”)

Clickable carrier

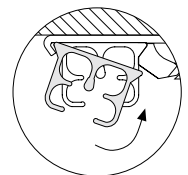

Easy installation
click - position - tighten

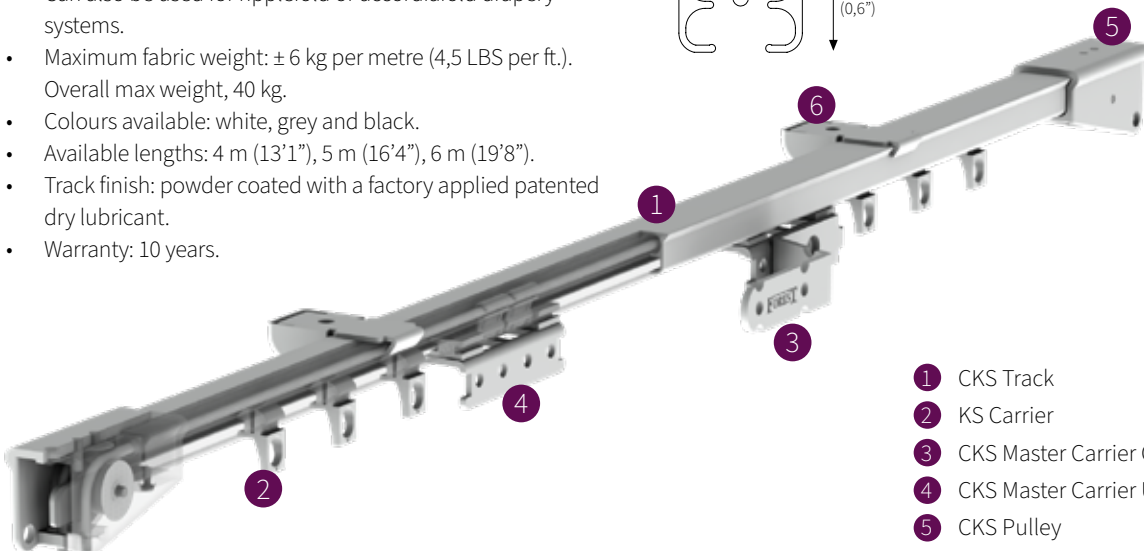

- 1 CKS Track
- 2 KS Carrier
- 3 CKS Master Carrier Overlap
- 4 CKS Master Carrier Underlap
- 5 CKS Pulley
- 6 Ceiling bracket with endcap



APPLICATIONS

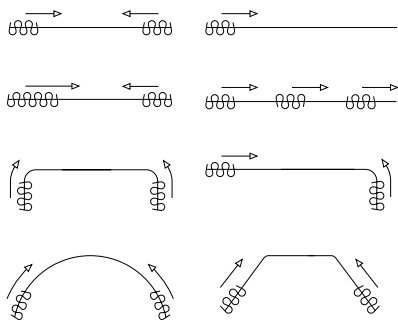

BENDING / CURVING

The track can be bent and reverse bent using a 10 cm (4") radius. Continuous curving can easily be done using the continuous curver or the electric powered bender.

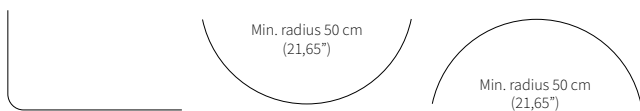

FOR USE IN

Hotels - offices - residences - boats - campers - planes or any location where an efficient cord traversing system is required.

MOUNTING BRACKETS

Wall bracket

3,5 cm (1,4"),
6 cm (2,4")

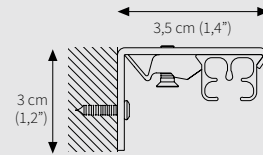

A) Min. 10 cm (4")



A) Min. 15 cm (6")



SK Ceiling Bracket

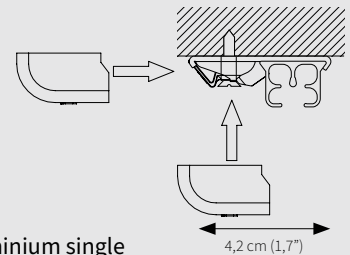

SK Wall bracket aluminium single

A) 7,5 cm (3")
B) 6,3 cm (2,5")

A) 10 cm (4")
B) 8,8 cm (3,5")

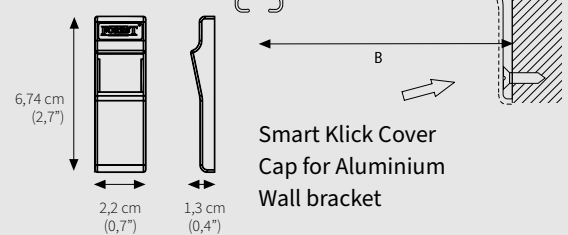

SK Wall bracket aluminium double

A) 15 cm (6") B) 9,2 cm (3,6") C) 4,5 cm (1,8")
A) 20 cm (8") B) 9,2 cm (3,6") C) 9,5 cm (3,7")

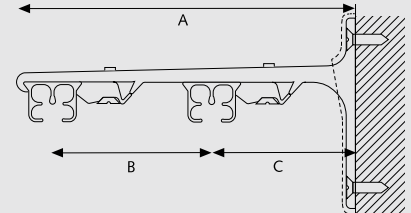

SK Wall bracket aluminium triple 25 cm (10")

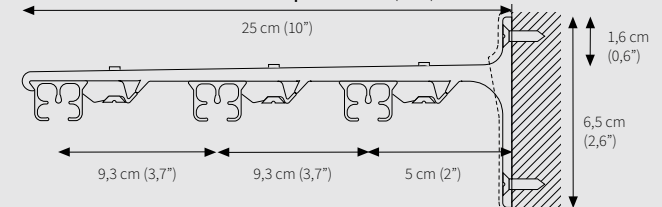

KS Adjustable Wall Bracket

8 cm (3,1") Ø 20 (0,8") or 28 mm (1,1"), adjustable to 9,5 cm (3,7").

A = 8,9 (3,5") / B = 8 (3,1") < > 9,5 (3,7") /

D = 3,75 (1,5") / E = 5,95 cm (2,3")

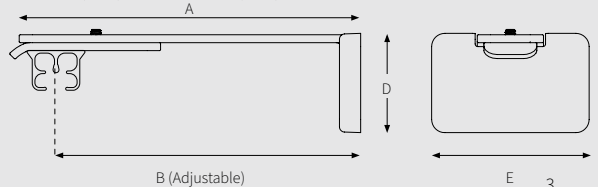

FOREST CCS® CORDED



PRODUCT INFORMATION

- Heavy duty cord operated system, with separate internal cord channels; preventing cord sag and eliminating cord tangle.
- Quick installation with “Smart Klick”. brackets for wall and ceiling applications.
- Bendable; it can be bent and reverse bent with a 20 cm (8”) radius or continuous curve.
- Heavy duty klickable carriers - 10 carriers on a breakaway strip - UV protected.
- Maximum fabric weight: 8 kg. per metre (5,3 LBS per ft). Overall max weight, 50 kg.
- Colours available: white, grey & black.
- Track finish: powder coated with a factory applied patented dry lubricant.
- Lengths available: 3.66 m (12’), 4.27 m (14’), 4.88 m (16’), 6.10 m (20’).
- Same brackets as used with Klick System.
- Warranty: 10 years.
- Not possible in combination with FES for wave pleat.

FEATURES

- Shown actual size 1:1
- Aluminium Extrusion
- Weight: 300 gram per metre (3.22 ounce per ft)
- Dimensions: 20 mm x 20 mm (3/4” x 3/4”)

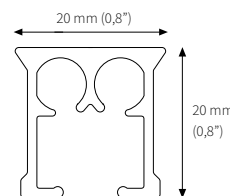

Easy installation
click - position - tighten

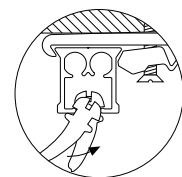

Klickable carrier

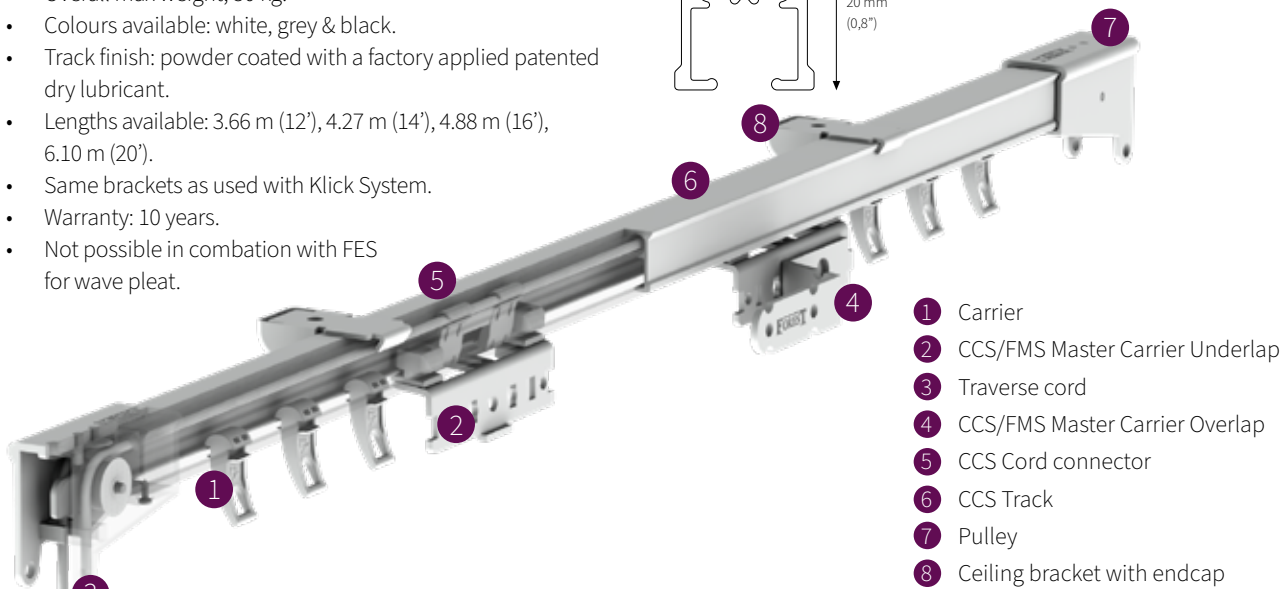



MOUNTING BRACKETS

SK Ceiling Bracket

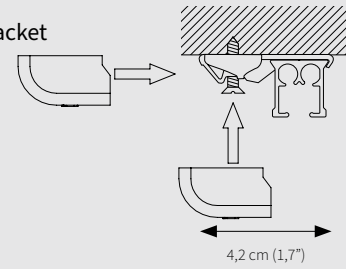

A) Min. 20 cm (8")

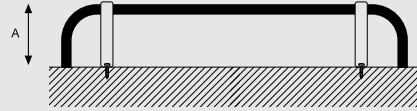

SK Aluminium Wall Bracket single

- A) 7,5 cm (3") B) 6,3 cm (2,5")
 A) 10 cm (4") B) 8,8 cm (3,5")

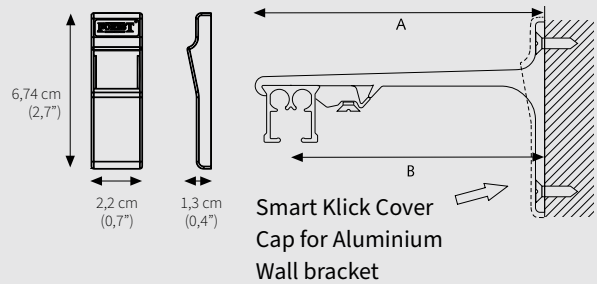

APPLICATIONS

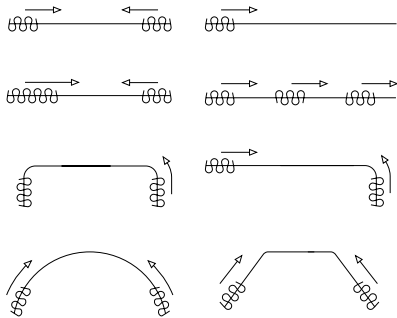

BENDING / CURVING

The track can be bent and reverse bent using a 20 cm (8") radius. Continuous curving can be done with the electric powered bender or by special order from factory.



FOR USE IN

Hotels - motels - offices - healthcare - schools - residential or any location where a heavy duty cord traverse system is required.

SK Wall bracket aluminium double

- A) 15 cm (6") B) 9,2 cm (3,6") C) 4,5 cm (1,8")
 A) 20 cm (8") B) 9,2 cm (3,6") C) 9,5 cm (3,7")

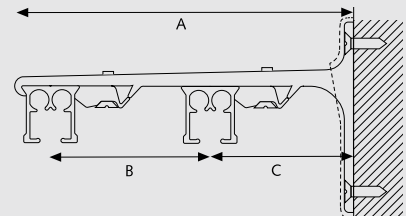

SK Wall bracket aluminium triple 25 cm (10")

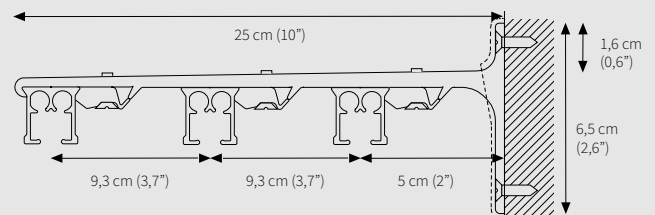

Brackets need to be placed every 50 - 60 cm (20"), depending on fabric weight.

KS Adjustable Wall Bracket

8 cm (3,1") Ø 20 (0,8") or 28 mm (1,1"), adjustable to 9,5 cm (3,7")
 A = 8,9 (3,5") / B = 8 (3,1") <> 9,5 (3,7") /
 D = 3,75 (1,5") / E = 5,95 cm (2,3")

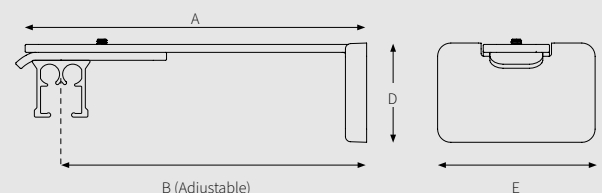

FOREST CRS® CORDED



PRODUCT INFORMATION

- Elegant and trendy cord-operated channel rod system.
- Curtain rod fitted with curtain carriers.
- Available dimension: 28 mm (1,1").
- Bendable, both with an inside and outside corner.
- Available in 7 colours: White-PC, Gold-AN, Anthracite-PC, Chrome, Inox-AN, Stonegrey-PC, Antique-PC.
- The brackets and endcaps are available in matching colours.
- Wide range of decorative finials offering great variety of design options.
- Length: 5,80 m (19").
- Rod quality: aluminium, powder coated or anodised.
- Easy and quick assembly.
- Forest Easyfold System (FES) for wave pleat also applicable on CRS Coded.
- Warranty: 10 years.

FEATURES

- Shown actual size 1:1
- Weight: 460 grams per metre
- Aluminium extrusion
- Dimension: 28 mm (1,1")

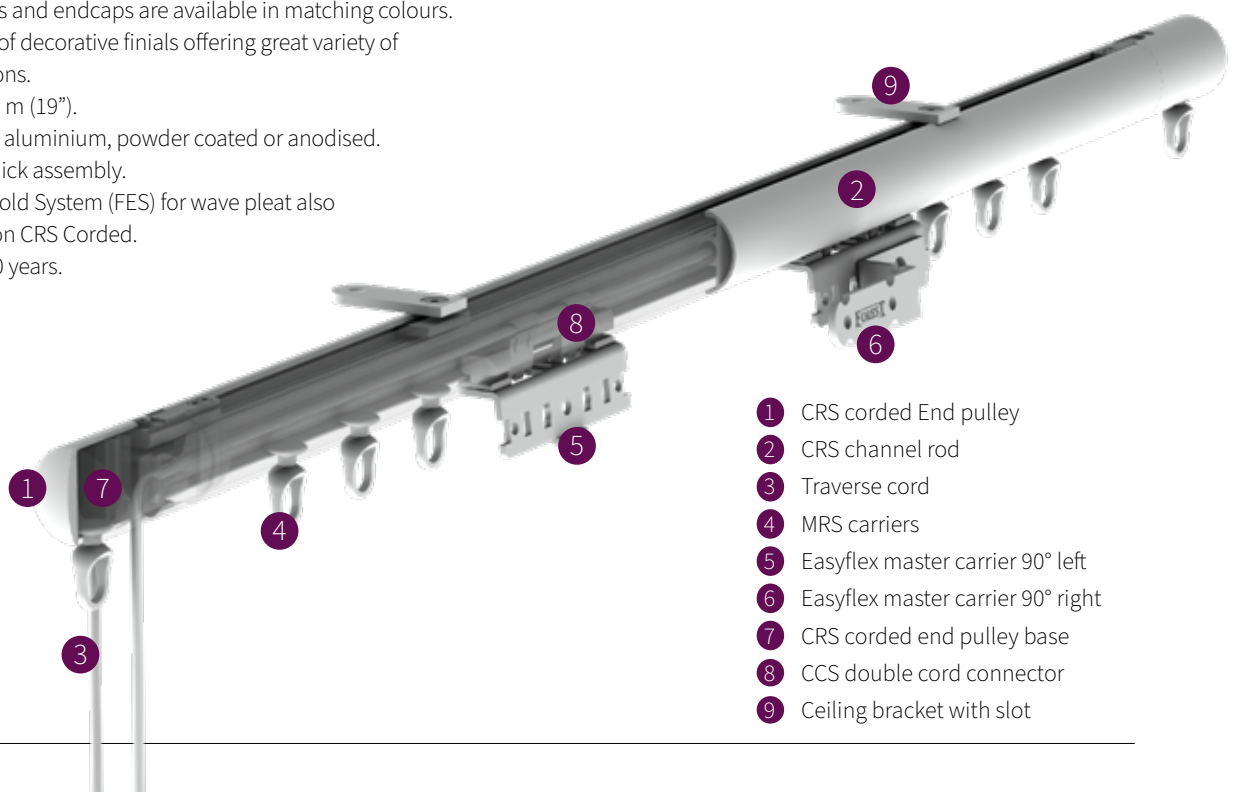
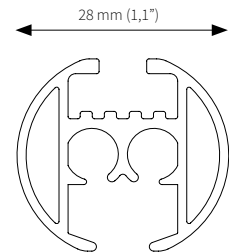

- 1 CRS corded End pulley
- 2 CRS channel rod
- 3 Traverse cord
- 4 MRS carriers
- 5 Easyflex master carrier 90° left
- 6 Easyflex master carrier 90° right
- 7 CRS corded end pulley base
- 8 CCS double cord connector
- 9 Ceiling bracket with slot



APPLICATIONS

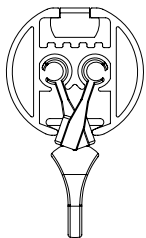
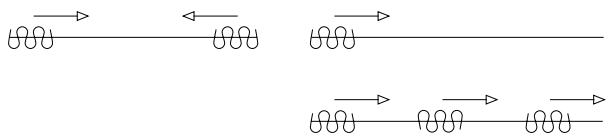

Cross-Section Channel Rod with cord connectors and carriers.

BENDING / CURVING

The 28 mm (1,1") rod can be curved and reverse curved by using a radius of 20 cm (8").

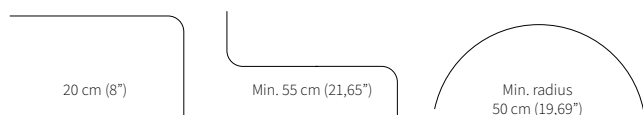

FOR USE IN

Domestic and / or contract market, or at any location where a high quality, elegant and corded operated channel rod system is required.

MOUNTING BRACKETS

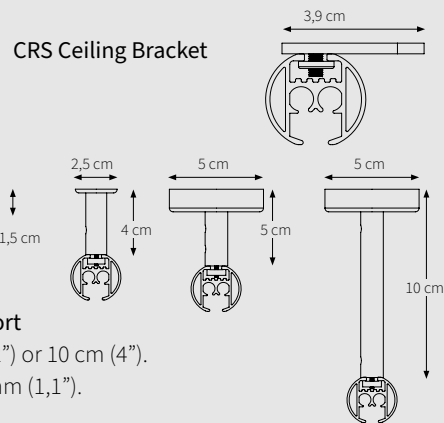

CRS Ceiling Support

4 cm (1,6"), 5 cm (2") or 10 cm (4").
20 mm (0,8") / 28 mm (1,1").

CRS Wall Bracket, single

8 cm (3,1"), 12 cm (4,7") and 16 cm (6,3")
(Base plate for the 12 cm (4,7") and 16 cm bracket is 6,2 cm (2,4"), similar to the double wall brackets.)

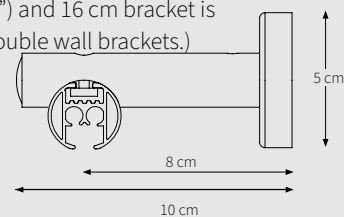

CRS Wall Bracket, double

16 cm (6,3") Ø 20 mm (0,8")
16 cm (6,3") Ø 28 mm (1,1")
20 cm (7,87") Ø 28 mm (1,1")

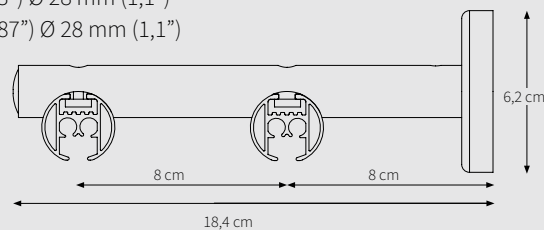

CRS Wall Bracket, double

16 cm (6,3") Ø 20 mm (0,8") (manual) /
28 mm (1,1") (corded)



CRS Adjustable Wall Bracket

8 cm (3,1") Ø 20 (0,8") or 28 mm (1,1"), adjustable to 9,5 cm (3,7").
A = 8,9 (3,5") / B = 8 (3,1") <> 9,5 (3,7") /
D = 3,75 (1,5") / E = 5,95 cm (2,3")

12 cm (4,7") Ø 20 (0,8") or 28 mm (1,1"), adjustable to 13,5 cm (5,3").
A = 12,9 (5,1") / B = 12 (4,7") <> 13,5 (5,3")
/ D = 3,75 (1,5") / E = 5,95 cm (2,3")

16 cm (6,3") Ø 20 (0,8") or 28 mm (1,1"), adjustable to 21 cm (8,3").
A = 18,9 (7,4") / B = 7,5 (3,0") <> 10,5 (4,1")
/ C = 9 (3,5") <> 10,5 (4,1") / D = 3,75 (1,5") / E = 5,95 cm (2,3")

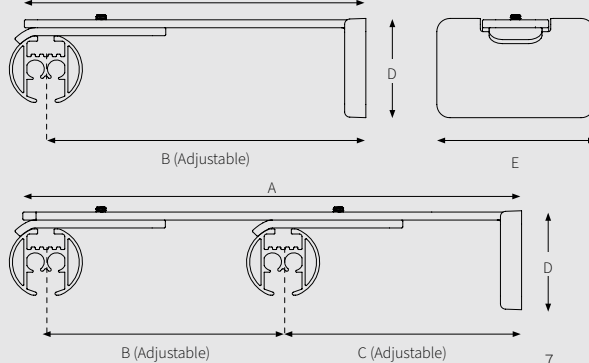

FOREST DS-XL® CORDED



With the DS-XL® Series, Forest offers curtain tracks that optimally combines design and functionality. The Design System XL gives every interior an extra visual appearance.

Stylish curtains deserve an elegant and fashionable curtain track. The DS-XL® Series provide a sleek finish and contribute to a unique design look at home or in any hotelroom.

Thanks to a symmetrical profile, the system can be mounted "blind" to the ceiling. This provides an extra sleek finish. The track is easy to mount by means of swivel supports or click supports.

The DS-XL® track system has been especially designed for use with our wave system, Forest Easyfold System. But it is also suitable with regular pleated curtain headings.

PRODUCT INFORMATION

- Elegant and aesthetical corded curtain track system.
- For all types of medium weight draperies.
- Quick and easy installation.
- Ceiling brackets and wall brackets available.
- Invisible ceiling brackets to fix track flush to ceiling available.
- Heavy duty carriers - uv protected - for smooth and easy traversing.
- Colours available: white, grey or anthracite with matching assembly components.
- Available length: standard stock size 6 metres (19.8").
- Especially designed for use in combination with our wave pleat system 'Forest Easyfold System'.
- Unique warranty: 10 years.

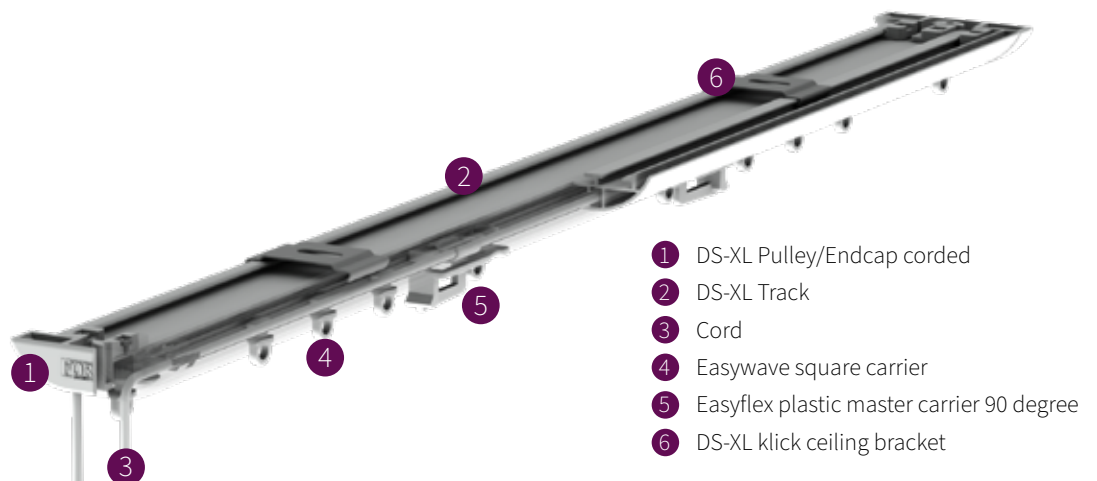

FEATURES

- Shown actual size 1:1
- Weight: 480 gr/metre
- Aluminium extrusion
- Size: 60 x 15 mm
- Colours: white, grey, anthracite

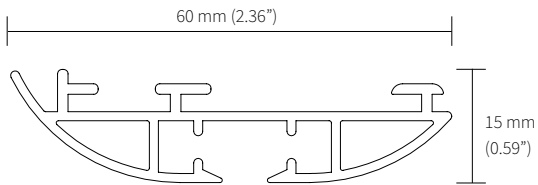

COLOUR OPTIONS

The DS-XL® is available in three colours: white, grey and anthracite.



FOR USE IN

Hotels, offices, residences, boats, campers, planes or anywhere an efficient and elegant track system is required for curtains and drapes.











Easyflex tape application on DS-XL® track.

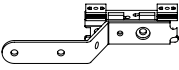
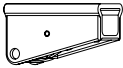
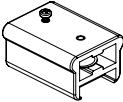
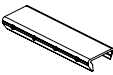



FOREST EASYFOLD SYSTEM

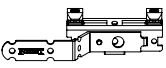

Opt for a regular pleated heading or choose for a more atmospheric effect for the Forest Easyfold System. The FMS® system has been designed for use with the Forest Wave-system. Our wave system is designed so that the curtains maintain their folding effect from the moment they are dressed.

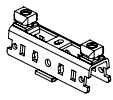
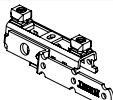
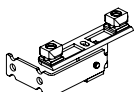
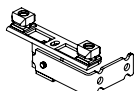
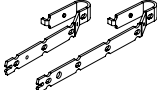
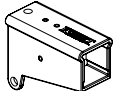

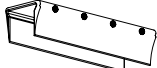



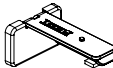
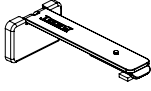
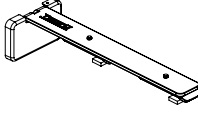

For more information about our wave system and basic components please refer to our Forest Easyfold brochure.

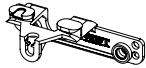
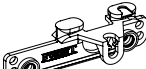

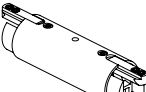

CKS corded	CCS corded	CRS corded	DS-XL corded	CKS TRACK+ PARTS	ARTICLE	PACKING UNIT	ART.NR
•					CKS TRACK 4 mtr. 5 mtr. 5 mtr. 6 mtr.	20/bundle white white grey black white	1501001400 1501001500 1501003500 1501006500 1501001600
•					CARRIER ASYMMETRICAL "Klickable", offset, constructed of UV resistant plastic. 10 Carriers on a break-away strip. Can be clicked in after installation. Also symmetrical carriers available.	500/box white grey black	1010001000 1010003000 1010006000
•					CKS MASTER CARRIER UNDERLAP R/L Will go through curves.	25/box white grey black	1515601000 1515603000 1515606000
•					CKS MASTER CARRIER OVERLAP R/L Will go through curves.	25/box white grey black	1515701000 1515703000 1515706000
•					CKS PULLEY Reversible, for two way draw.	25/box white grey black	1530101000 1530103000 1530106000
•					CKS END PULLEY SHORT Especially for one-way closing of the curtain.	25/box white grey black	1530101011 1530103011 1530106011
•					CKS TRACK JOINER	10/box white grey black	1018401010 1018403010 1018406010
•					CKS CORD CONNECTOR Connects cord to the CKS Master Carrier.	100/box white black	1530301000 1530306000
					CKS CORD Connector Half Connects cord to the CKS Master Carrier.	100/box white	1530311000
•	•	•	•		TRAVERSE CORD Polyester drapery cord designed for smooth slide, Ø 3.5 mm (0,14"), 16 ply. Suitable for CKS / CCS / CRS / DS-XL Corded	250 mtr/roll white grey black	1030401000 1030403000 1030406000



CKS corded	CCS corded	CRS corded	DS-XL corded	CCS TRACK+ PARTS	ARTICLE	PACKING UNIT	ART.NR
	•				CCS TRACK 3.66 mtr. 4.27 mtr. 4.88 mtr. 6.10 mtr. 6.10 mtr. 6.10 mtr.	10/bundle white white white white grey black	3001001366 3001001427 3001001488 3001001610 3001003610 3001006610
	•				CCS CARRIER SMALL Contract click carrier patented, clickable. UV-resistant POM plastic.	250/box white grey black	2510101000 2510103000 2510106000
	•				FMS/CCS/MRS WHEEL CARRIER The wheel carrier goes smoothly over a splice.	100/box white	5210101002
	•				CCS CORD MASTER CARRIER R/L OVERLAP Multifunctional - reversible arm - will go through curves, will also fit stiffeners and cord connector.	15/box white grey gold black	3015701000 3015703000 3015702000 3015706000

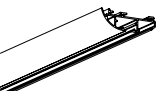

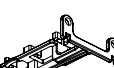



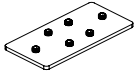
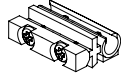

					CCS MASTER CARRIER UNIVERSAL R/L	15/box	white matt white (RAL9016) grey black matt black (RAL9005)	3015601000-U 3015601000-M 3015603000-U 3015606000-U 3015606000-M
					CCS/FMS MASTER CARRIER UNIVERSAL R/L (SINGLE LONG)	15/box	white grey black	3016001000-U 3016003000-U 3016006000-U
					EASYFLEX MASTER CARRIER 90 DEGREE LEFT for center draw	15/box	white black	4815351090 4815356090
					EASYFLEX MASTER CARRIER 90 DEGREE RIGHT for center draw	15/box	white black	4815451090 4815456090
					PROLONGED ARM FOR MASTER CARRIER 150 mm long Click On 150 mm long Click On 200 mm long Click On	15/box	white black white	9500001010 9500006010 9500001020
					CCS PULLEY Voor middensluitend pakket	25/box	white grey black	3030101000 3030103000 3030106000
					INSIDE WALL BRACKET For additional support anywhere the pulley meets the wall.	25/box		3022301000
					END PULLEY SMALL Reversible, for non-stacking side on one way draw.	25/box	white grey black	3030201000 3030203000 3030206000
					CCS RAIL CONNECTOR	10/box	white grey black	2518401000 2518403000 2518406000-A
					CCS DOUBLE CORD CONNECTOR Connects cord to the CCS master carrier.	20/box	white grey black	3030301010 3030303010 3030306010
					TRAVERSE CORD Polyester drapery cord designed for strong smooth slide, Ø 3.5 mm (0,14"), 16 ply. Suitable for CKS/CCS/CRS/DS-XL Corded DS-XL Corded	250 mtr/roll	white grey black	1030401000 1030403000 1030406000



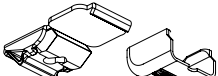

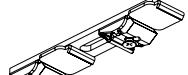

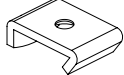
CKS corded	CCS corded	CRS corded	DS-XL corded	CRS TRACK+ PARTS	ARTICLE	PACKING UNIT		ART.NR
					CRS CHANNEL ROD CORDED Ø 28 mm (1.1") Extruded aluminium, chromated, powder coated incl. inlay strip	5.80 mtr/tube	white gold-an inox-an stonegrey antique-pc anthracite-pc chrome	5811281580-PC 5811282580 5811283580 5811283580-SG 5811289580-PC 5811286580-PC 5701287520
					CRS CARRIER ROUND	500/box	white grey black	5810101000 5810103000 5810106000
					CRS ADJUSTABLE WALL BRACKET 8CM INCL. COVER	2/box	white stonegrey-pc anthracite antique	5830001080 5830003080-SG 5830005080 5830009080
					12CM INCL. COVER		white stonegrey-pc taupe anthracite antique	5830001120 5830003120-SG 5830004120 5830005120 5830009120
					16CM DUBBEL INCL. KAP		white stonegrey-pc taupe anthracite antique	5830001160 5830003160-SG 5830004160 5830005160 5830009160



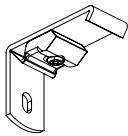
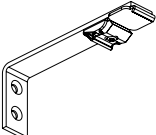
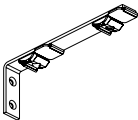
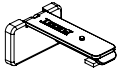

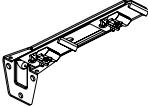
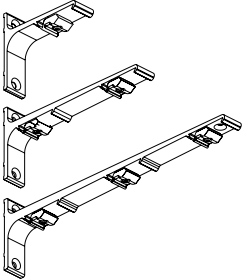

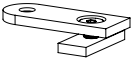
CKS corded	CCS corded	CRS corded	DS-XL corded	CRS TRACK+ PARTS	ARTICLE	PACKING UNIT	ART.NR
		•			EASYFOLD PLASTIC MASTER UNDERLAP	25/box	white grey black transparent 4815201010 4815203010 4815206010 4815201000
		•			EASYFOLD PLASTIC MASTER STRAIGHT/OVERLAP	25/box	white grey black transparent 4815101010 4815103010 4815106010 4815101000
		•			FMS MASTER CARRIER UNIVERSAL R/L "CLICK-ON"	15/box	white grey black 5215801010-U 5215803010-U 5215806010-U
		•			CRS CORDED END PULLEY COMPLETE	2/box	white gold inox-an stonegrey antique-pc taupe-pc anthracite-pc 6130201001-PC 6130202001 6130203001 6130203001-SG 6130209001-PC 6130204001-PC 6130206001-PC
		•			CRS CORDED CENTRE PULLEY COMPLETE	2/box	white inox-an stonegrey antique-pc taupe-pc anthracite-pc 6130251001-PC 6130253001 6130253001-SG 6130259001-PC 6130254001-PC 6130256001-PC
		•			CRS RAIL CONNECTOR (6 CM)	10/box	5815200006
		•			CRS CORNER CONNECTOR (5 CM)	10/box	5815200007
	•	•			CCS DOUBLE CORD CONNECTOR	100/box	white grey black 3030301010 3030303010 3030306010
•	•	•	•		TRAVERSE CORD Polyester drapery cord designed for smooth slide, Ø 3.5 mm (0,14"), 16 ply. Suitable for CKS / CCS / CRS / DS-XL Corded	250 mtr/roll	white grey black 1030401000 1030403000 1030406000
		•			CRS METAL ENDSTOP WITH SCREW 18 MM End stop for securing the outermost glider for a centre-opening curtain stack	100/box	5816101001
		•			CRS METAL ENDSTOP WITH SCREW-EYE	100/box	for 20 mm (0,8") for 28 mm (1.1") for 20 mm long 5816102000 5816102001 5816102002



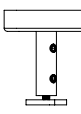

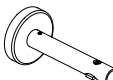
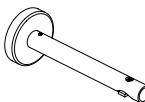
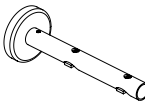
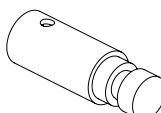
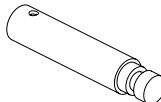

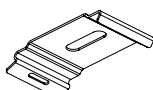

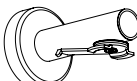

CKS corded	CCS corded	CRS corded	DS-XL corded	DS-XL TRACK+ PARTS	ARTICLE	PACKING UNIT	ART.NR
			•		DS-XL RAIL, 6 mtr (19*8")	24 mtr/bundle	white grey anthracite 3916101600 3916103600 3916105600
			•		ECONOMY CARRIER SMALL	500/box	white black 3910101000 3910106000
			•		EASYFLEX PLASTIC MASTER CARRIER 90 DEGREE	15/box	white grey black 3916701000 3916703000 3916706000
			•		DS-XL ENDCAP CORDED metal	20/box	white grey anthracite 3916201001-ZA 3916203001-ZA 3916205001-ZA

					DS-XL TRACK CONNECTOR STRAIGHT	10/box		3916401000
					DS-XL CORD CONNECTOR	100/box	white black	3916301000 3916306000
					TRAVERSE CORD Polyester drapery cord designed for smooth slide, Ø 3.5 mm (0,14"), 16 ply. Suitable for CKS / CCS / CRS / DS-XL Corded	250 mtr/roll	white grey black	1030401000 1030403000 1030406000
					DS-XL END STOP	100/box		3916001000

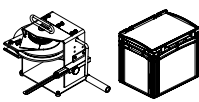
CKS corded	CCS corded	CRS corded	DS-XL corded	MOUNTING	ARTICLE	PACKING UNIT		ART.NR
					CEILING BRACKET Slides onto the track, powder coated. Regular duty	100/box	white grey black beige	1018001000 1018003000 1018006000 1018012000
					CEILING BRACKET WITH SLOT Slides onto the track, powder coated. Regular duty Slotted support makes fixing curtain track easier.	100/box	white grey black creme beige	1018101000 1018103000 1018106000 1018111000 1018112000
					SMART KLICK CEILING BRACKET Powder coated, "klicks" onto track. Attach with VK-4 mm screw.	100/box	white grey black	1018201000 1018203000 1018206000
					SMART KLICK CEILING BRACKET INCL. COVER CAP	100/box	white grey black	1018201001 1018203001 1018206001
					COVER CAP FOR SMART KLICK BRACKETS Suitable for Smart Klick Wall-and Ceiling bracket.	100/box	white grey black anthracite	1019201000 1019203000 1019206000 1019204000
					FALSE CEILING BRACKET (METAL) For installation on to a suspended (system) ceiling. The track can be fixed in any angle as the bracket is rotatable.	25/box	white black	4519001000 4519006000
					SMART KLICK DOUBLE CEILING BRACKET LARGE Distance between two tracks: 90 mm (3,5")	30/box	white	1018601000
					SMART KLICK DOUBLE CEILING BRACKET SHORT Distance between two tracks: 45 mm (1,8")			1018611000
					FSS MOUNTING BRACKET For concealed installation or ceiling installation in narrow spaces. Heavy Duty.	100/box		7160001000
					KS CEILING SPLICE BRACKET For ceiling installation only, powder coated.	50/box	white grey black	1018501000 1018503000 1018506000
					KS KLICK-ON CEILING BRACKET For concealed installation without visible brackets, light weight use only.	100/box	white grey black	1018301000 1018303000 1018306000

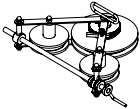
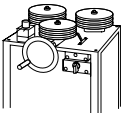
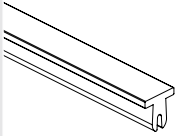
CKS corded	CCS corded	CRS corded	DS-XL corded	MOUNTING	ARTICLE	PACKING UNIT		ART.NR
					SMART KLICK WALL BRACKET 3,5 cm "Klicks onto track, powder coated. One screw attachment. Maximum load: 20 kg/mtr.	50/box	white grey black	1020201035 1020203035 1020206035
•	•				SMART KLICK WALL BRACKET 6 cm "Klicks onto track, powder coated. One screw attachment. Maximum load: 15 kg/mtr.		white grey black	1020201060 1020203060 1020206060
					SMART KLICK WALL BRACKET 7,5 cm "Klicks onto track, powder coated. One screw attachment. Maximum load: 12,5 kg/mtr.		white grey black	1020201075 1020203075 1020206075
•	•				KS SMART KLICK WALL BRACKET 10 cm Maximum load: 10 kg/mtr.	20/box	white grey	1020201100 1020203100
					KS SMART KLICK WALL BRACKET 12,5 cm Maximum load: 2 kg/mtr.	20/box	white grey	1020201125 1020203125
					KS SMART KLICK WALL BRACKET 15 cm Maximum load: 2 kg/mtr.	15/box	white grey	1020201150 1020203150
					KS SMART KLICK WALL BRACKET 20 cm Maximum load: 2 kg/mtr.	15/box	white grey	1020201200 1020203200
					KS SMART KLICK WALL BRACKET 25 cm	10/box	white grey	1020201250 1020203250
					KS SMART KLICK WALL BRACKET 30 cm	10/box	white grey	1020201300 1020203300
•	•				KS SMART KLICK WALL BRACKET DOUBLE Maximum load: 2 kg/mtr.	15/box	10 cm 15 cm 20 cm	1020601100 1020601150 1020601200
•	•				KS ADJUSTABLE WALL BRACKET 8CM INCL. COVER	2/box	white matt white grey matt black	1020901080 1020901080-mat 1020903080 1020906080-mat
•	•				KS ADJUSTABLE WALL BRACKET, SINGLE 7.5 CM - 11.5 CM	100/box	white grey	1020801115 1020803115
•	•				KS ADJUSTABLE WALL BRACKET, DOUBLE 6.5 CM - 19.5 CM	50/box	white grey	1020801195 1020803195
•	•				ALUMINIUM SK WALL BRACKET 7,5 CM SINGLE. "Klicks onto track, powder coated. Maximum load: 25 kg/mtr.	20/box	white grey black	1020301075 1020303075 1020306075
					ALUMINIUM SK AFSTANDSTEUN 10 cm ENKEL. "Klicks onto track, powder coated. Maximum load: 20 kg/mtr.	20/box	white grey black	1020301100 1020303100 1020306100
					ALUMINIUM SK AFSTANDSTEUN 15 cm DUBBEL. "Klicks onto track, powder coated. Maximum load: 13 kg/mtr.	15/box	white grey black	1020301150 1020303150 1020306150
					KS ALUMINIUM SK AFSTANDSTEUN 20 cm - DUBBEL. "Klicks onto track, powder coated. Maximum load: 9 kg/mtr.	15/box	white grey black	1020301200 1020303200 1020306200
					ALUMINIUM SK AFSTANDSTEUN 25 cm TRIPLE. "Klicks onto track, powder coated. Maximum load: 5 kg/mtr.	10/box	white grey	1020301250 1020303250
•	•				SMART KLICK COVER CAP ALUMINIUM BRACKET UNIVERSAL	50/box	white grey black	1021301000 1021303000 1021306000
		•			CRS CEILING BRACKET LONG Ø28 MM	100/box	white stone grey anthracite black antique	5818003101-LA 5818003103-SG 5818009103-LA 5818006103-LA 5818009104-LA
		•			CRS CEILING BRACKET 1,5 CM	4/box	white inox-an stonegrey taupe anthracite antique	5818212028-PC 5818232028 5818232028-SG 5818242028-PC 5818252028-PC 5818292028-PC

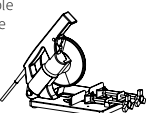
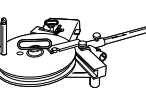
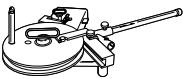
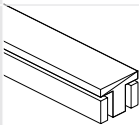
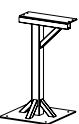
CKS corded	CCS corded	CRS corded	DS-XL corded	MOUNTING	ARTICLE	PACKING UNIT		ART.NR
		•			CRS CEILING SUSPENSION BRACKET 4 CM (1.57") Ø 20/28 MM	2/box	white gold inox-an stonegrey black antique-pc anthracite-pc chrome	5818112000 5818122000 5818132000 5818132000-SG 5818162000-PC 5818192000-PC 5818152000-PC 5818012028
		•			CRS CEILING SUSPENSION BRACKET 5 CM (1.96") Ø 20/28 MM	2/box	white gold inox-an stonegrey antique-pc	5818112028 5818122028 5818132028 5818132028-SG 5818192028-PC
		•			CRS WALL BRACKET SINGLE 8 CM (3.15") Ø 28 MM	2/box	white gold inox-an stonegrey black antique-pc taupe-pc anthracite-pc chrome	5820080128 5820080228 5820080328 5820080328-SG 5820080628-PC 5820080928-PC 5820080428-PC 5820080528-PC 5820080728
		•			CRS WALL BRACKET SINGLE 12 CM (4.72") Ø 28 MM	2/box	white gold inox-an stonegrey black antique-pc taupe-pc anthracite-pc chrome	5820120128 5820120228 5820120328 5820120328-SG 5820120628-PC 5820120928-PC 5820120428-PC 5820120528-PC 5820120728
		•			CRS WALL BRACKET SINGLE 16 CM (6.29") Ø 28 MM	2/box	white gold inox-an stonegrey black antique-pc taupe-pc anthracite-pc	5820160128 5820160228 5820160328 5820160328-SG 5820160628-PC 5820160928-PC 5820160428-PC 5820160528-PC
		•			CRS WALL BRACKET DOUBLE 16 CM (6.29") Ø 28 MM	2/box	white gold inox-an stonegrey black antique-pc taupe-pc anthracite-pc	5822160128 5822160228 5822160328 5822160328-SG 5822160628-PC 5822160928-PC 5822160428-PC 5822160528-PC
		•			CRS WALL BRACKET EXTENSION 4 CM	10/box	white gold inox-an stonegrey black antique-pc anthracite-pc chrome	5815201030 5815202030 5815203030 5815203030-SG 5815206030-PC 5815209030-PC 5815205030-PC 5715107040
		•			CRS WALL BRACKET EXTENSION 8 CM		gold inox-an stonegrey black antique-pc chrome	5815102020 5815103020 5815103020-SG 5815106020-PC 5815109020-PC 5715107080
		•			CRS ADJUSTABLE BRACKET EXTENSION	10/box	white inox-an stonegrey black antique-pc	5815101070 5815103070 5815103070-SG 5815106070-PC 5815109070-PC
			•		DS-XL KLICK CEILING BRACKET	100/box		3918301000
			•		DS-XL CEILING SWIVEL BRACKET	100/box	white anthracite	3818200230 3818205230
			•		DS-XL WALL BRACKET 9 CM	5/box	white anthracite	3820001018 3820005018

CKS corded	CCS corded	CRS corded	DS-XL corded	BENDING PARTS AND OTHER ITEMS	ARTICLE	PACKING UNIT	ART.NR	
•	•	•	•		TENSION PULLEY White	25/box	1030501000	
•	•	•	•		ASSEMBLY TOOL FOR CORD CONNECTOR	1/each	9510000027	
•	•	•	•		CORD/CHAIN WALL MOUNT SAFETY BOX SINGLE	25/box	3645702000	
•	•	•	•		CORD/CHAIN WEIGHT DESIGN 110 GR WIT	10/box	white grey black	3030701000 3030703000 3030706000
•	•	•	•		FOREST LUBRICANT SPRAY For ultra-smooth and quiet operation. Suitable for use during assembly and for maintenance after installation.	1/each	5109010000	
•					KS/DS BENDING HOUSE COMPACT ALL-IN Includes lubricant spray, angle finder and bending case. Exclu- des bending wheel and strips.	1/each	1050000000	
					KS RECESS BENDING WHEEL ALL-IN incl. strips + wedges	1/each	1050100000	
•					KS/DS BENDING CASE Box for storing all bending components of the KS/CKS system. Dimensions: 40x30x33.5 cm. Box excludes all components.	1/each	1050000001	
•					CONTINUOUS CURVER Add on tool for the Compact Bending Tool. Designed to create continuous curves and arches in any radius. Includes KS ben- ding strip. For KS and CKS Track only.	1/box	1060200000	
•	•				ELECTRIC POWERED BENDER For creating continuous curves. Minimum radius 50 cm.	1/box	230V 110V	1060500000 1060500001
•					CKS REPLACEMENT BENDING STRIP For Compact Bending Tool. Length of strip: 60 cm (23")	1/each	1560100000	
					For Continues Curver / electric bender. Length of strip: 7 mtr. (23")		1560300000	
•					BENDING WHEELS For electric powered bender. Complete set of 3 wheels.	1/set	1060700000 2560700000	
					For KS/CKS track. For CS/CCS track.			
•	•			sample image 	ELECTRIC POWERED RAILCUTTER 230 Volt EU	1/each	1061100000	
					BLADE FOREST CUTTER NEW MODEL	1/each	1061200001	
	•				CONTRACT BENDING TOOL For CS/CCS/FMS/CRS/MTS	1/each	2560000000	
					CS/CCS/FMS Bending Wheel	1/each	2561000000	
	•				CCS BENDING STRIPS, COMPLETE SET For CCS track, length: 90 cm.	1/set	8500000002	
					FOR CCS ELECTRIC POWERED BENDER. Length 7 meter (23').	1/each	8500000010	
	•				BENDING STANDARD Standard for Contract bending tool 28 mm	1/each	2560800000	
	•				BENDING WHEELS For Electric Powered Bender. Complete set of 3 wheels only for CS en CCS rail.	1/set	2560700000	